

Agilent PSG Signal Generators

Aerospace and defense

- Radar and electronic warfare
- Secure communications
- Satellite communications

Commercial communications

- Broadband wireless access
- Point-to-point/multipoint digital microwave radio
- Mobile communications

General purpose

- Component analysis
- LO and clock substitution
- Interference generation



Agilent Technologies

Setting a Higher Standard



E8257D PSG analog signal generator



E8267D PSG vector signal generator

High performance signal generation solutions ranging from CW only to advanced signal simulation

Higher frequency, higher power, and higher performance

Agilent PSG signal generators provide the microwave signal generation technology for your expanding test needs. Featuring the industry's first analog signal generator with frequency ranges up to 67 GHz (operational to 70 GHz) and vector signal generator up to 44 GHz, the PSG is poised to accelerate innovation for your high frequency designs in the aerospace, defense, and communications industries. PSG signal generators maintain worldwide leadership in microwave signal generation by offering the frequency coverage, feature set, and performance you need to be successful in today's increasingly technical test environment.

When performing functional and parametric tests on advanced RF and microwave radio systems, analyzing the components that comprise them, or simply substituting a continuous-wave (CW) signal for a local oscillator, the PSG delivers high quality signals to test your state-of-the-art designs. Generate pulsed signals for radar test, vector-modulated signals for receiver bit error rate (BER) analysis, and even play back simulated waveforms for advanced system-level verification...with PSG signal generators, the possibilities are endless. Choose from two PSG models to meet your signal generation requirements: the E8257D PSG analog and the E8267D PSG vector.

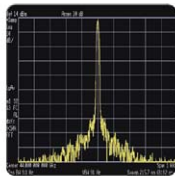

continuous wave

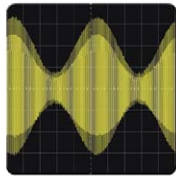

analog modulation

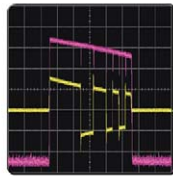

pulse modulation

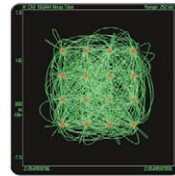

digital modulation

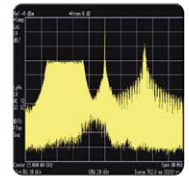

signal simulation



E8257D PSG Analog Signal Generator

ANALOG
ANALOG
ANALOG
ANALOG
ANALOG
ANALOG

Benchmark signal quality

An industry-leading combination of phase noise and output power performance has given PSG analog signal generators a reputable name in the test industry. These fundamental attributes, along with precision analog and pulse modulators have made the PSG the instrument of choice for RF and microwave design engineers worldwide. The E8257D PSG analog signal generator offers excellent output power and level accuracy up to 70 GHz, exceptional close-to-carrier phase noise, wider deviation for FM and Φ M, and frequency extensions up to 325 GHz using Oleson Microwave Labs (OML) mm-wave source modules. With this capability and performance the PSG continues to be the worldwide leader in microwave signal generation.

Modular platform

PSG signal generators feature a modular platform with room to grow – serving your test needs now and in the future. The highly flexible option structure enables you to configure the PSG to accommodate your specific test applications as well as your budget requirements. Choose from multiple options to tailor the performance of the PSG, such as frequency range, output power, phase noise, types of modulation, and more. And since most options can be retrofitted yourself or at an Agilent Service Center, you can select the performance you need today, knowing you can quickly and easily upgrade later.

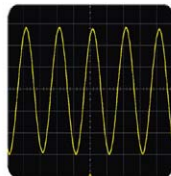

CW

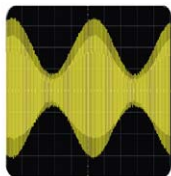

AM

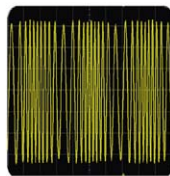

FM

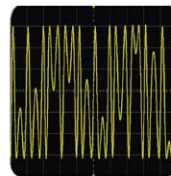

Φ M

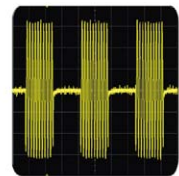

pulse



CW signal generation

- 250 kHz to 20, 31.8, 40, 50, or 70 GHz
- Industry leading output power
- Precision level accuracy
- Low phase noise
- Swept frequency and power
- Frequency extensions to 325 GHz using OML mm-wave source modules
- Code compatibility eases automation during test system upgrades¹

Plus optional analog and pulse modulation

- Two internal LF function generators with sine, square, triangular, ramp, and noise waveforms
- Deep log and linear AM
- Scan modulation
- Wideband DC-synthesized FM and Φ M
- Narrow pulse modulation

1. Code compatibility available for the Agilent 834xB, 837xx, 836xx, E824x/E825xA, and E82x7C microwave signal generators and Agilent 8662A, 8663A, E4428C, E443xB, and E4438C RF signal generators.



E8257D PSG Analog Signal Generator

Designed for your test applications

ANALOG
ANALOG
ANALOG
ANALOG
ANALOG

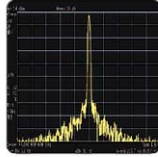

Ideal for LO substitution and low jitter clock replacement
Boasting the widest frequency range, exceptional spectral purity, and high output power, the PSG analog is ideal for LO

substitution and low jitter clock replacement. The PSG's industry-leading phase noise and spurious performance minimizes distortion products that would normally be translated directly to the mixer products. This results in less stringent filter requirements at the mixer output and improved signal quality for minimum test uncertainty. With clearly specified low jitter characteristics, you need not worry about the PSG contributing to the system clock error. If your application only requires CW signals, the PSG's modular architecture allows a lower acquisition cost since analog and pulse modulators are optional.



Unrivalled for component analysis
Accuracy, repeatability, and speed are essential to meet your test throughput goals. For component analysis and stimulus response applications,

the PSG offers high output power, outstanding level accuracy, low harmonics and spurious distortion, and fast analog and digital sweep of frequency and power. Analog (AM, FM, and Φ M) and pulse modulators can also be applied during sweep operation. Using a high performance microwave signal generator in combination with a scalar network analyzer or PSA spectrum analyzer for swept analysis applications you will realize the benefits of economy, convenience, and extended dynamic range in one measurement system.

Use as a tracking generator with the PSA spectrum analyzers



Use as a swept source for scalar network analysis

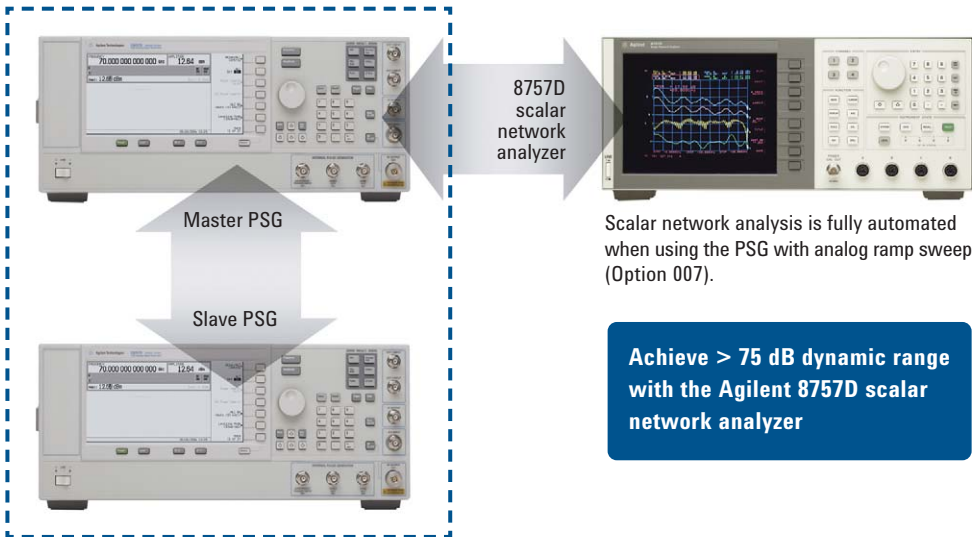

Achieve > 75 dB dynamic range with the Agilent 8757D scalar network analyzer

Supports master/slave operation for swept two-tone signal generation.



E8257D PSG Analog Signal Generator

Delivering power, spectral purity, and wideband analog modulation

ANALOG
ANALOG
ANALOG
ANALOG
ANALOG

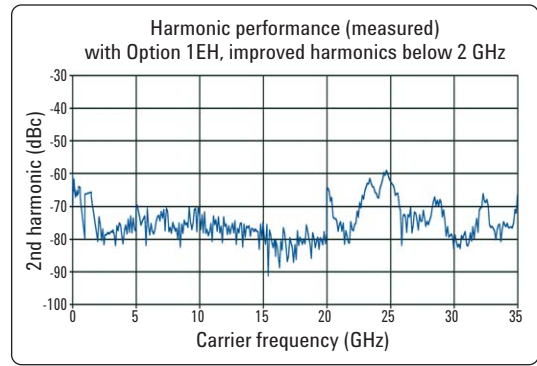
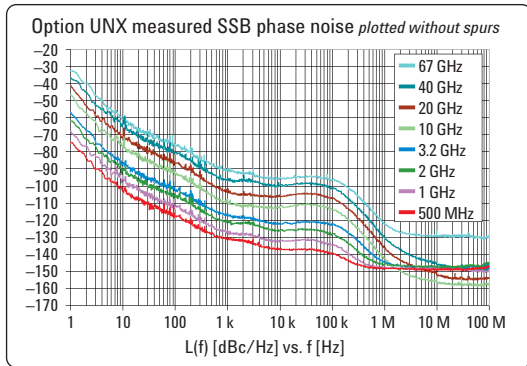
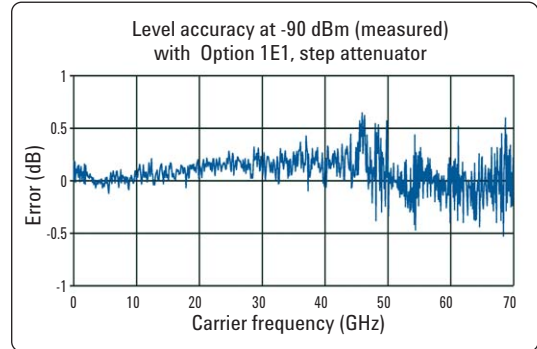
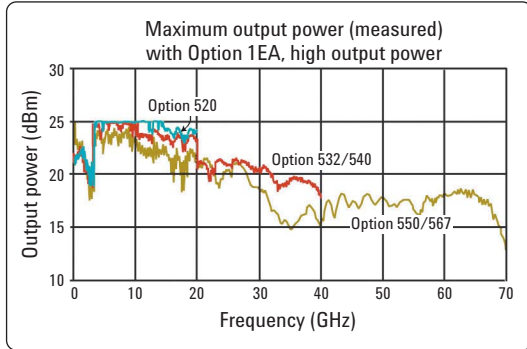

Specification summary¹

Ultra low phase noise (Option UNX)

$f_c = 10$ GHz	
(100 Hz offset)	-92 dBc/Hz
(1 kHz offset)	-109 dBc/Hz
(10 kHz offset)	-114 dBc/Hz
(100 kHz offset)	-115 dBc/Hz

High output power (Option 1EA)

at 20 GHz	+ 23 dBm
at 30 GHz	+ 19 dBm
at 40 GHz	+ 17 dBm
at 50 GHz	+ 14 dBm
at 67 GHz	+ 14 dBm
67 to 70 GHz	+ 8 dBm

Level accuracy

(CW level = -10 to +10 dBm)	
$f_c = 2$ to 20 GHz	± .8 dB
$f_c = 20$ to 40 GHz	± .9 dB
$f_c = 40$ to 50 GHz	± .9 dB ²
$f_c = 50$ to 67 GHz	± 1.0 dB ³

Switching speed

(list mode) < 5 ms (meas)

Analog modulation (Option UNT)

AM	
Bandwidth	100 kHz
Depth	
Linear	> 95%
Exponential	> 40 dB
FM	
Bandwidth	dc to 10 MHz
Maximum deviation	
20 GHz < f_c ≤ 40 GHz	64 MHz
40 GHz < f_c ≤ 67 GHz	128 MHz
ΦM	
Bandwidth	dc to 1 MHz
Maximum deviation	
20 GHz < f_c ≤ 40 GHz	640 radians
40 GHz < f_c ≤ 67 GHz	1280 radians

Narrow pulse modulation (Option UNW)

Rise/fall time	8 ns
Minimum pulse width	20 ns
On/off ratio	80 dB

1. Numbers in italics indicate typical performance. Specifications subject to change without notice.
 2. ±1.3 dB for 0 to +10 dBm
 3. ±1.5 dB for 0 to +10 dBm

Accelerating
Innovation

E8267D PSG Vector Signal Generator

Step up to integrated vector technology

An industry first...vector signal generation at microwave frequencies. The E8267D PSG offers an outstanding feature set that drastically simplifies the generation of complex vector modulated signals for design and manufacturing test applications in radar, satellite communications and broadband communications. With frequency ranges up to 44 GHz, the PSG vector

provides groundbreaking functionality with built-in wideband I/Q modulator with up to 2 GHz RF modulation bandwidth (BW) and an advanced wideband (80 MHz BW) internal baseband generator capable of flexible arbitrary waveform playback and sophisticated real-time signal generation.

VECTOR
VECTOR
VECTOR
VECTOR
VECTOR
VECTOR

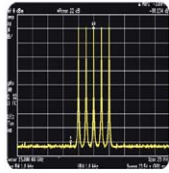

multitone

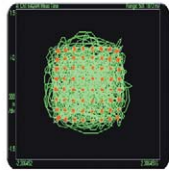

digital modulation

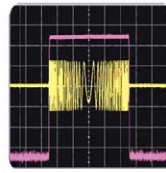

FM chirp pulse

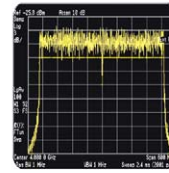

wideband modulation

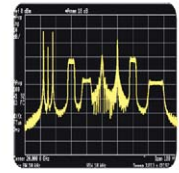

signal simulation



Built on the foundation of analog performance

- Industry-leading phase noise
- High output power
- Precision level accuracy

Integrated vector solution

- 250 kHz to 20, 31.8, or 44 GHz
- Integrated wideband I/Q modulator
- External I/Q inputs (up to 2 GHz BW)
- Internal baseband generator (up to 80 MHz BW)
 - Arbitrary waveform playback with sequencing
 - Real-time I/Q symbol generation
 - Digital modulation: FSK, PSK, MSK, QAM, custom I/Q
 - Single and multicarrier (up to 100 carriers)
 - 16-bit upsampling DACs running at 400 MHz
 - Up to 64 MSa waveform playback memory
 - Up to 6 GB waveform storage
- Signal Studio software for signal creation
- Baseband Studio for digital I/O and waveform capture/playback

Plus optional analog capability

- Two internal LF function generators with sine, square, triangular, ramp, and noise waveforms
- Deep log/linear AM and scan modulation
- Wideband DC-synthesized FM, and Φ M
- Narrow pulse modulation
- Swept frequency and power
- Frequency extensions to 325 GHz using OML mm-wave source modules¹
- Tracking capability with PSA Series spectrum analyzers
- Code compatibility eases automation during test system upgrades²

1. Frequency extensions with OML mm-wave source modules do not support vector modulation.

2. Code compatibility available for the Agilent 834xB, 837xx, 836xx, E824x/E825xA, and E82x7C microwave signal generators and Agilent 8662A, 8663A, E4428C, E443xB, and E4438C RF signal generators.

Accelerating
Innovation

E8267D PSG Vector Signal Generator

VECTOR
VECTOR
VECTOR
VECTOR
VECTOR
VECTOR

Eliminate upconversion

If you've spent time building a custom upconversion solution to generate vector-modulated signals at microwave frequencies, then you know the difficulties surrounding conversion loss, filtering, repeatability, calibration, and support. Agilent's E8267D PSG is the world's first commercial off-the-shelf signal generator to address these issues with an integrated solution for vector modulation at microwave frequencies up to 44 GHz. Extend your test capability and lower your cost of ownership with this state-of-the-art microwave technology.

Modern microwave test

The PSG vector signal generator is built on the PSG analog's proven foundation of performance and it is equipped with signal creation tools, advanced baseband generation, and integrated wideband I/Q modulation, to simplify signal simulation. It provides a repeatable calibrated test stimulus with unprecedented flexibility, output power, and signal quality for your test applications. And it's all backed by Agilent support.

The PSG can be configured to address very specific test applications and still provide general-purpose signal generation capabilities, making it the most versatile signal generator in the world. This breakthrough in technology is transforming microwave test from a custom approach to a systematic method that streamlines integration, improves throughput, and drives interoperability. Modernizing your test systems with the PSG vector signal generator will ultimately help get your products to market faster by accelerating test and improving yield.

Solutions for vector modulation at microwave frequencies

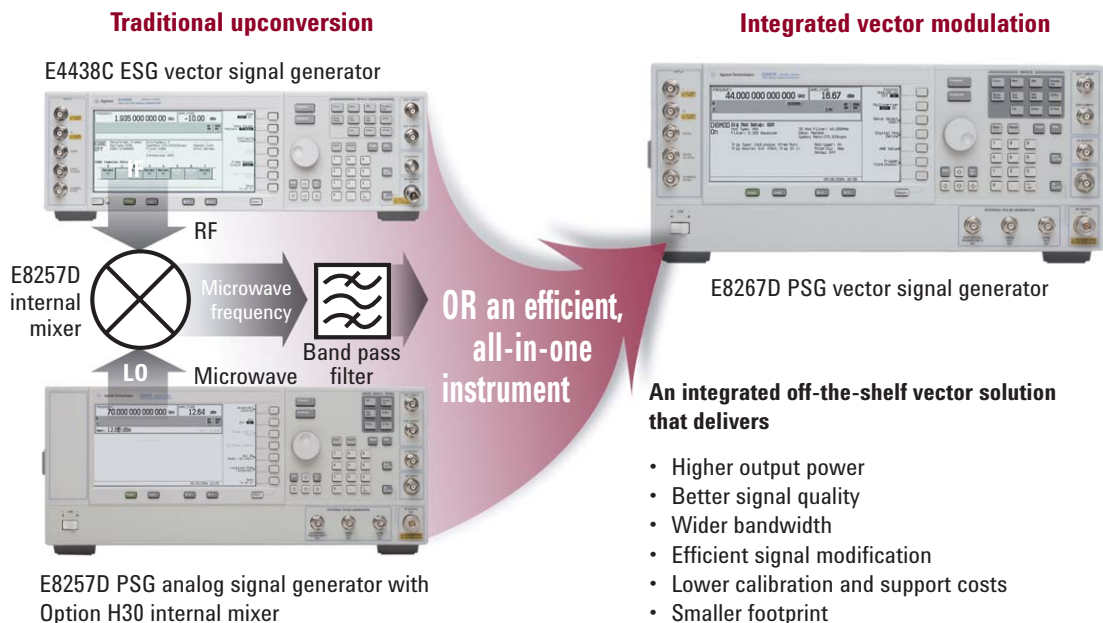



E8267D PSG Vector Signal Generator

A complete stimulus solution

VECTOR
VECTOR
VECTOR
VECTOR
VECTOR
VECTOR

The PSG vector features the most complete set of calibrated test signals for your radio systems, ranging from digital and analog baseband to modulated signals up to mm-wave frequencies. With this single signal generator, you can fully exercise the individual functional stages of your radio designs with baseband, IF, RF and microwave test signals – displacing the need for

independent pattern and function generators, arbitrary waveform generators, and analog signal generators. The PSG streamlines the integration process and reduces costly design iterations because the same test stimulus is used across all design stages, eliminating possible sources of error.

Test all sections of your receiver and transmitter designs

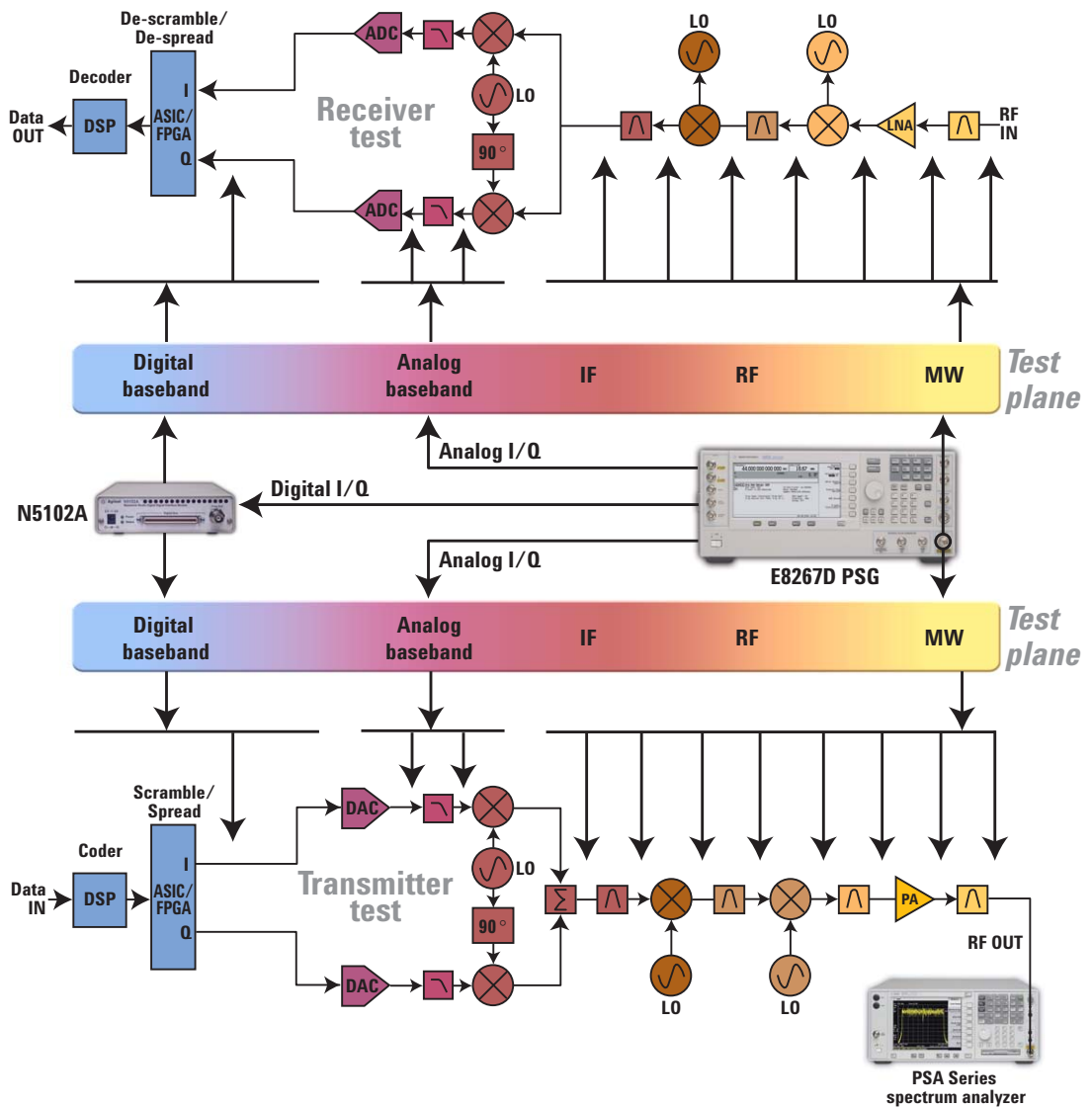

Accelerating
Innovation

E8267D PSG Vector Signal Generator

Realistic signal simulations

VECTOR
VECTOR
VECTOR
VECTOR
VECTOR
VECTOR

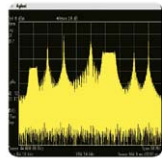

Vector modulation opens up signal simulation possibilities that are simply unattainable with analog modulation. With the PSG vector signal generator, it is easier than ever before to create realistic signal simulations to test radar and electronic warfare, satellite, and broadband wireless communications systems. Whether performing parametric tests on components and devices or functional tests on subsystems and systems, two advantages of testing with realistic signal simulations are clear:

- 1) identify and address issues early in the design process when they are less costly to remedy and
- 2) gain confidence that when deployed, your designs are successful.

Featuring an internal baseband generator capable of arbitrary waveform playback and real-time I/Q signal generation, plus support for external arbitrary waveform generators with RF modulation bandwidths up to 2 GHz, you now have convenient access to advanced signal simulation technology to generate real-world test signals up to 44 GHz.

With integrated, calibrated, wideband vector signal generation at your fingertips, the signal simulation possibilities are endless. Easily add a variety of signal impairments, simulate interference conditions, and even generate phase coherent signals to test direction finding and other multi-receiver systems.

The PSG is the perfect complement to your RF and microwave signal simulation and analysis lab. When combined with Agilent Advanced Design System software, PSA Series spectrum analyzers, 89600 Series vector signal analyzers and software, and Infiniium oscilloscopes, you have the bandwidth and dynamic range necessary to successfully develop your high performance radio designs and the flexibility to ensure you've exercised all possible operating conditions.

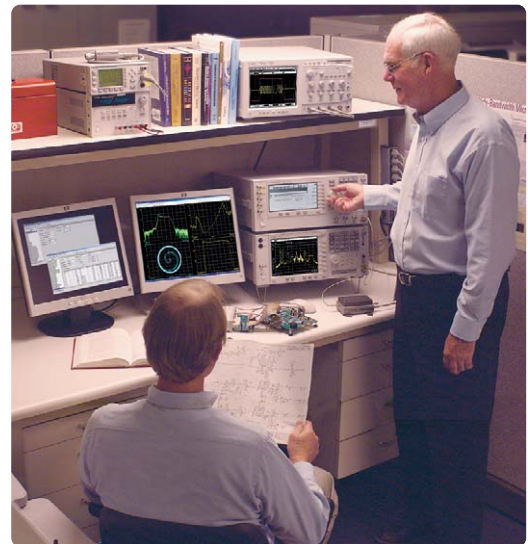

Modern test solutions for your advanced radio designs.

Accelerating
Innovation

E8267D PSG Vector Signal Generator

Designed for your test applications

VECTOR
VECTOR
VECTOR
VECTOR
VECTOR
VECTOR

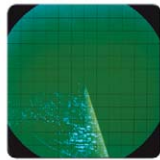

Radar

The PSG vector signal generator utilizes deep waveform playback memory, flexible waveform sequencing, and wideband I/Q modulation to generate complex pulse patterns for radar receiver tests. What used to require racks of test equipment to simulate radar test signals can now be accomplished in a single integrated instrument.

Using the PSG's vector-modulated arbitrary waveforms improves repeatability and eliminates many of the synchronization issues associated with pulsing modulated signals using traditional analog techniques. Simply define arbitrary waveforms representing pulsed radar signals using Agilent Signal Studio for pulse building, Agilent Advanced Design System (ADS), or other popular waveform creation tools, including MATLAB®, and download them to the PSG for playback. With full control over pulse frequency, phase, amplitude, and modulation characteristics on a pulse-by-pulse basis, you can generate the long non-repetitive pulse patterns you need to fully test your advanced radar systems.



Satellite

Due to the high risk and cost associated with launching a satellite, extensive testing is required while designing and developing the navigation, control, and communications systems. It is critical to ensure that each functional block of the satellite will operate properly when deployed. Payload test systems have generally relied on custom upconversion based test solutions to produce vector modulated test signals at microwave frequencies. These systems require significant effort to generate repeatable calibrated test signals.

Investing in a single integrated instrument, like the PSG, that features flexible signal generation and guaranteed calibrated performance can save you valuable time in your current test processes, increase the accuracy of your test results, and enable new test possibilities. With a single PSG vector signal generator, you can easily produce digitally modulated signals, custom pulse patterns, multitone distortion test signals, or even playback hours of unique custom waveforms when used with Baseband Studio. Test with the most advanced microwave signal generator available and feel confident during the launch pad countdown.

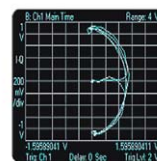

Broadband communications

Modern commercial and military communications systems, such as WLAN, WiMAX, and UWB, and secure tactical radio systems continue to employ wider and wider bandwidths to increase data rates and counteract frequency selective fading. Using “golden devices” or a home brew solution to test your broadband communications systems can save you money up front, but end up costing you money in the long run since they tend to be un-calibrated, inflexible, and yield an overall high cost of ownership. In these highly competitive, continually evolving industries, the PSG vector can quickly adapt to your test needs, save you money and improve your time to market.

Using the PSG you can easily generate reference signals to perform bit-error-rate (BER), packet-error-rate (PER), and frame-error-rate (FER) analysis on your receiver designs. With a high fidelity wideband signal generation capability up to 800 MHz bandwidth using Signal Studio toolkit, the PSG is ready to tackle your most demanding test requirements.

Accelerating Innovation

E8267D PSG Vector Signal Generator

VECTOR
VECTOR
VECTOR
VECTOR
VECTOR
VECTOR

Flexible signal generation

The PSG integrates the three fundamental components of vector signal generation with the utmost flexibility: I/Q signal creation, I/Q baseband generation, and I/Q modulated RF and microwave signal generation. Using a combination of embedded signal creation software and PC-based Signal Studio software, the PSG simplifies complex signal simulation and enables you to quickly realize your desired test stimulus.

The PSG supports both internal and external baseband generators, such as the N6030A arbitrary waveform generator, and is compatible with Baseband Studio products for advanced baseband capability. All this, combined with calibrated I/Q modulation up to 44 GHz, gives you the most complete set of test signals for advanced radio design.

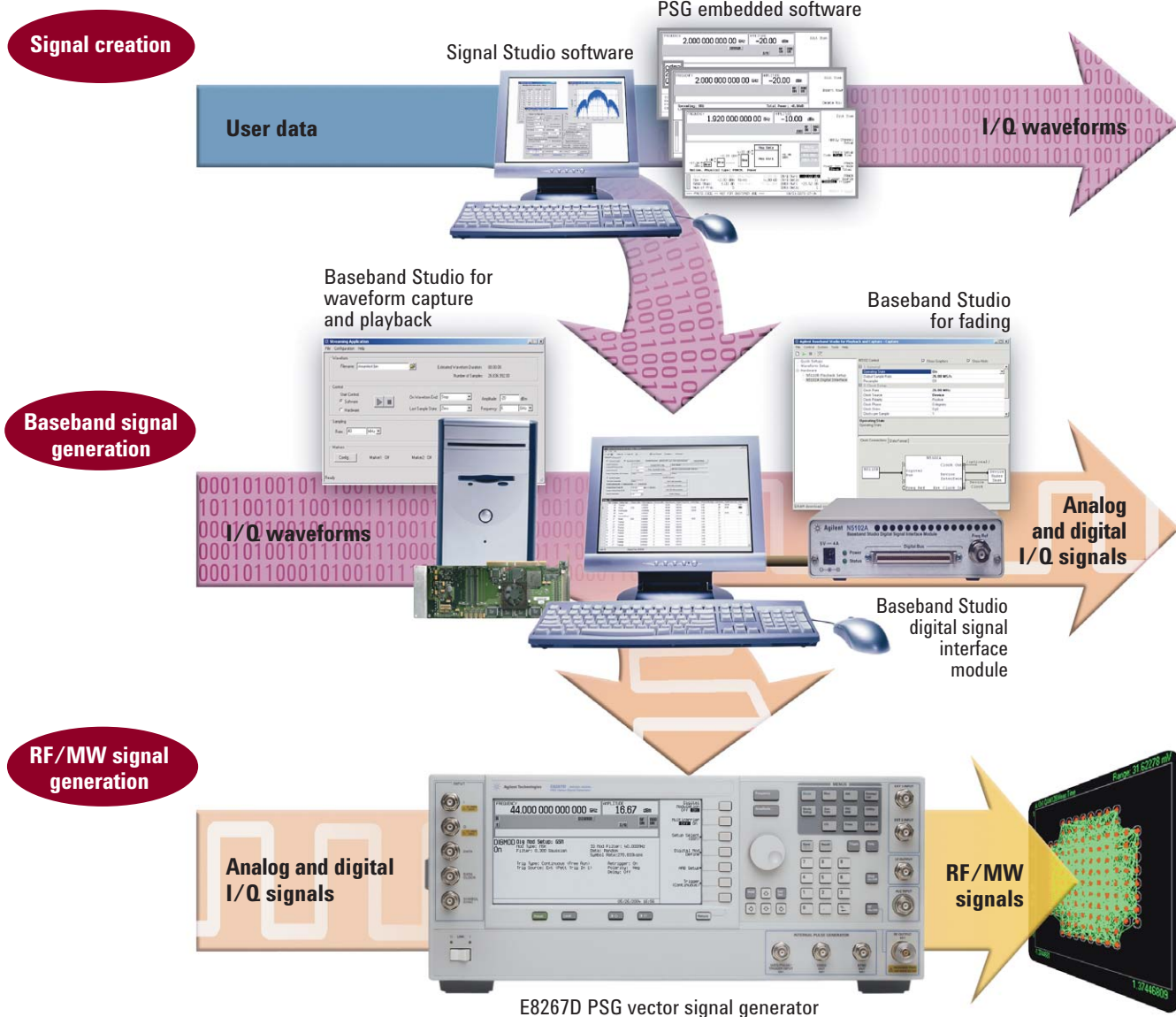

Accelerating
Innovation

E8267D PSG Vector Signal Generator

Simplify signal creation

VECTOR
VECTOR
VECTOR
VECTOR
VECTOR
VECTOR

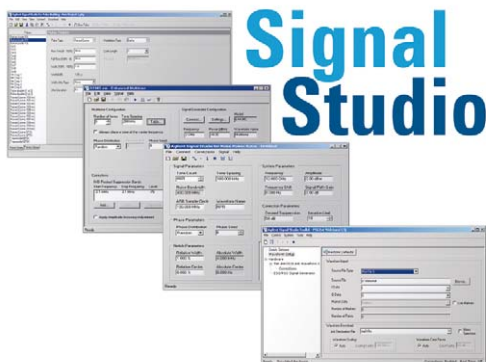

Further expand E8267D PSG signal generation capabilities with the addition of one of the many application specific, easy-to-use signal creation software products. Signal Studio, a suite of PC-based software, and software embedded in the E8267D allow you to set various signal parameters for flexible and simple I/Q waveform creation. Agilent signal creation software reduces the time you spend on custom signal simulation at microwave frequencies while enabling you to better characterize, evaluate, and optimize your designs.

Download Signal Studio to a PC to review the user interface and investigate the signal creation capabilities of the software prior to purchase. www.agilent.com/find/signalstudio

General microwave

- Multitone
- Toolkit
- Jitter injection
- AWGN
- NPR

Wireless connectivity

- WiMAX
- WLAN
- UWB

Detection, tracking, positioning and navigation

- Pulse building

Mobile communication

- W-CDMA
- cdma2000
- TDMA

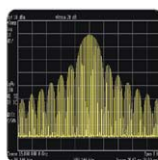

Create pulse patterns for radar receiver test

Signal Studio for pulse building enables flexible generation of complex pulse patterns. It provides a simple interface to construct and import custom pulse envelopes and apply various modulation types including Barker-coding and FM chirp. Full control over amplitude, frequency, phase and time is available on a pulse-by-pulse basis. Advanced sequencing capability facilitates the creation of sophisticated single emitter test patterns for radar receiver tests. Signal Studio for pulse building also features an advanced correction

algorithm to enhance the signal quality of the test stimulus directly at the input of the device under test (DUT).

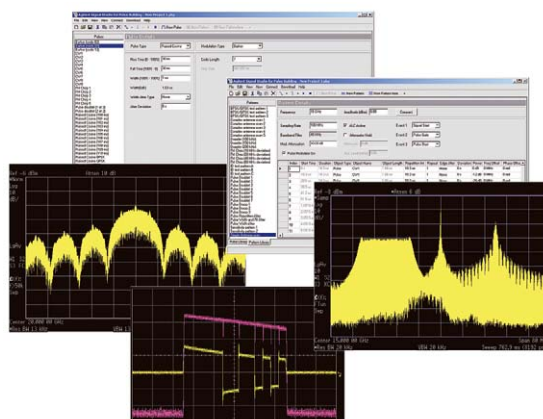



E8267D PSG Vector Signal Generator

Simplify signal creation

VECTOR
VECTOR
VECTOR
VECTOR
VECTOR
VECTOR

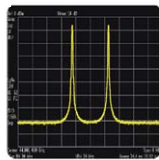

Create two-tone and multitone signals for distortion test

Signal Studio for enhanced multitone optimizes the intermodulation distortion performance of two-tone and multitone test stimuli to accurately characterize non-linear distortion performance of your device under test (DUT). The software uses an advanced correction algorithm to provide a multitone test stimulus, virtually free of intermodulation distortion (IMD) products, directly at the input of the device under test.

Using vector modulation, a single PSG is able to create up to 1024 tones to stress your DUT with high crest factor signals. This technique provides superior signal quality and reduces test complexity and cost as compared to the traditional approach of summing multiple CW signals at RF.

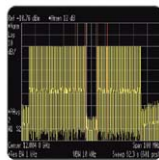
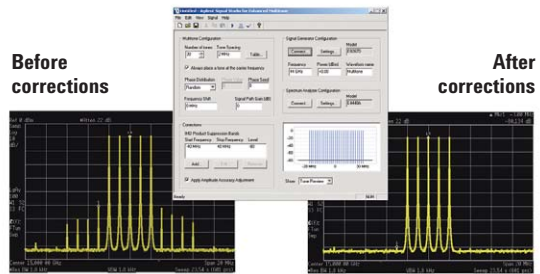

Create noise signals to measure noise power ratio

Signal Studio for noise power ratio (NPR) creates a test stimulus with over 60 dBc notch depth, without using sensitive bandpass filters. You can accurately measure, with minimal uncertainty, the non-linear distortion performance of your DUT. And, easily configure a wideband noise signal with a user-defined notch width positioned within the noise bandwidth. An advanced correction algorithm is used to increase the notch dynamic range and improve noise flatness of the NPR

test stimulus directly at the input of the DUT. The enhanced signal quality and digital accuracy significantly reduces test uncertainty and improves repeatability as compared to traditional analog NPR test methods.

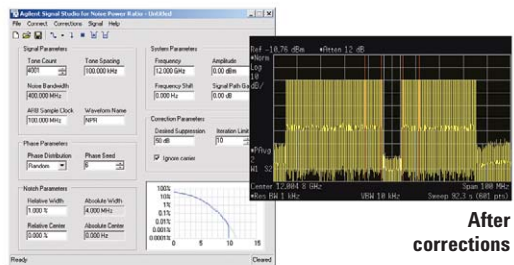

Inject calibrated jitter for tolerance measurements

Signal Studio for jitter injection precisely creates periodic jitter and/or random jitter on CW signals sourced from the PSG vector signal generator. These test signals can be used to verify your high-speed digital transmission systems clock recovery and regenerations circuit's tolerance to unwanted jitter. Both jitter subcomponents are available at clock rates ranging from 250 kHz to 44 GHz to evaluate your DUT at data rates up to 44 Gb/s. The software takes advantage of the PSG's

advanced complex IQ modulation capability to provide calibrated additive jitter with digital accuracy and repeatability.

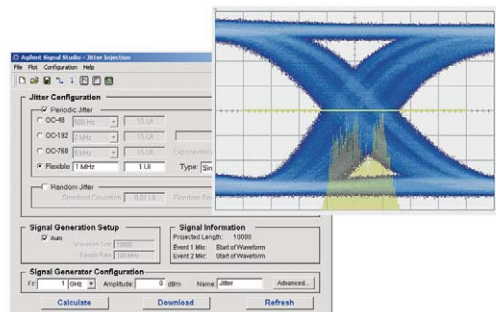



E8267D PSG Vector Signal Generator

Simplify signal creation

VECTOR
VECTOR
VECTOR
VECTOR
VECTOR
VECTOR

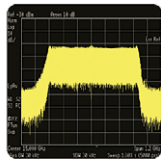

Create high fidelity wideband signals

Signal Studio toolkit is a software utility that simplifies waveform translation and downloading to the target

baseband generator, and optionally applies corrections to your custom I/Q waveforms. These corrections optimize RF flatness, phase linearity, and image rejection over bandwidths up to 800 MHz. Multiple file formats are supported and automatically translated to the appropriate file format for the PSG's internal baseband generator and supported external baseband

generators. The translation and downloading capability of this tool is available at no charge to facilitate the playback of your custom waveforms.

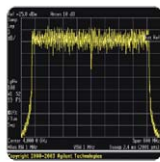
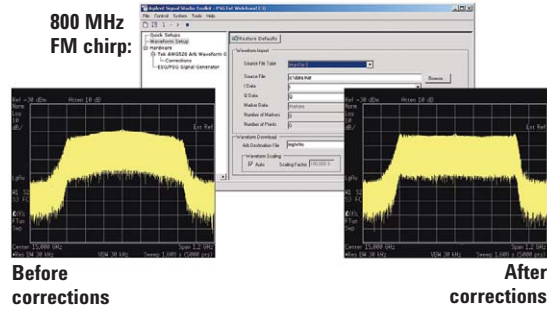

Create UWB radio frequency signals for receiver testing

Signal Studio for multiband OFDM UWB enables designers to generate waveforms compliant with the Multiband

OFDM Alliance proposal 802.15.3a. Use the software to build individual waveform segments, each with unique parameters, and combine them into one waveform for playback with the PSG and the N6030A wideband arbitrary waveform generator. Quickly and easily create signals for testing transceiver clock accuracy, sensitivity and interference rejection. With the addition of Signal Studio toolkit and a PSA or ESA series spectrum analyzer, you can perform accurate waveform correction to ensure minimal phase and amplitude distortion of the signal.

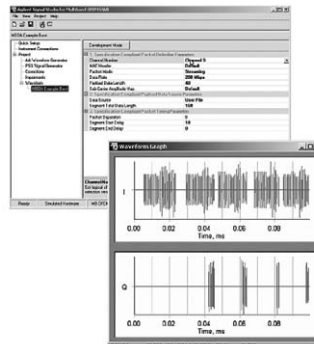

Measured flatness before and after corrections

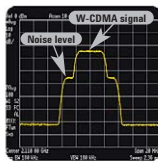
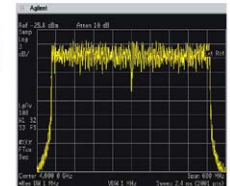

AWGN

Quickly and conveniently transform the PSG into a flexible additive white Gaussian noise (AWGN) source with calibrated noise software embedded on the PSG. The software provides two modes of operation: arbitrary and real-time waveform playback allowing for uncorrelated

noise with a bandwidth that can be continuously varied up to 80 MHz. Also, add calibrated noise to signals created with select Signal Studio software and precisely adjust signal-to-noise power directly from the software interface. The uncorrelated nature of the test stimulus is ideal for generating noise interference and is especially important for determining receiver performance.

E8267D PSG Vector Signal Generator

Options for advanced baseband generation

VECTOR
VECTOR
VECTOR
VECTOR
VECTOR
VECTOR



Internal baseband generator

The PSG vector signal generator equipped with the optional internal baseband generator (options 601/602) integrates advanced baseband capability with a state-of-the-art vector signal generator to facilitate complex I/Q modulation at microwave frequencies. The high performance dual mode baseband generator combines arbitrary waveform generation (ARB mode)

with sophisticated real-time I/Q symbol generation (real-time mode) to provide a complete baseband solution.

- Built-in single/multicarrier custom modulation and multitone signal creation
- Continuous data streams with variable symbol rates
- Flexible arbitrary waveform sequencing
- 80 MHz RF modulation bandwidth
- 16-bit, hardware oversampling 400 MHz DACs
- Variable sample rate up to 100 MHz
- Up to 64 MSa waveform playback memory
- Up to 1 GSa non-volatile waveform storage
- Signal Studio software compatible
- Baseband Studio compatible



Wideband arbitrary waveform generator

For complex wideband signal generation at microwave frequencies, Agilent N6030/31A arbitrary waveform generators combined with the PSG

vector signal generator deliver unprecedented performance. High sampling rate and high bit resolution enable designers to create ideal waveforms for accurate test of radar, satellite and frequency agile systems. Each channel of the N6031A provides 500 MHz of modulation bandwidth and over 50 dBc of spurious free dynamic range. Achieve even greater dynamic

range, over 65 dBc, with the N6030A. When the N6030/31A are used with the PSG's wideband I/Q modulator, you can realize authentic signal simulations with RF modulation bandwidth of up to 1 GHz for IF and RF subsystem test.

- 1.25 GSa/s sample clock
- 15 bits of vertical resolution
- Dual channel operation
- Differential and single-ended outputs
- Up to 16 MSa waveform memory
- Multiple module synchronization
- Up to 512k definable waveform segments
- Up to 256k unique definable sequences
- Complete instrument control from MATLAB®
- Compatible with CompactPCI and PXI mainframes

Accelerating
Innovation

E8267D PSG Vector Signal Generator

Extend your test capability with Baseband Studio

Baseband Studio is a suite of baseband signal applications and accessories that extend the capability of the PSG vector signal generator. Evaluate the Baseband Studio software

prior to purchase by downloading from the Agilent Web site.

www.agilent.com/find/basebandstudio

VECTOR
VECTOR
VECTOR
VECTOR
VECTOR
VECTOR



Add digital I/O

The N5102A Baseband Studio digital signal interface module

provides flexible digital inputs and outputs for your PSG. In the input mode, the interface module ports your digital input to the PSG's baseband system, providing a quick and easy way of converting to calibrated analog I/Q and upconverting to calibrated analog IF, RF or MW frequencies. In output mode, the interface module delivers

realistic complex-modulated signals, such as communications signals and custom pulses, sourced from the PSG's internal baseband generator directly to your digital subsystems and devices. In both operating modes, the interface module adapts to your device with the logic type, data format, clock features, and the signaling types you require. With its three-meter extension cable and a selection of connector types, the interface module connects easily to your device, in most cases eliminating the need for custom fixtures.

Accelerating
Innovation

VECTOR
VECTOR
VECTOR
VECTOR
VECTOR
VECTOR

E8267D PSG Vector Signal Generator

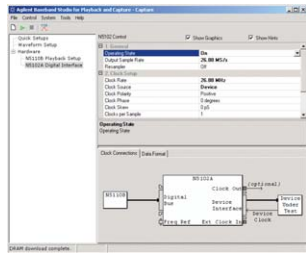

Add waveform capture and playback

N5110B Baseband Studio for waveform capture and playback combines the speed and memory you need

to capture and playback long time records of custom I/Q waveforms. Many applications, such as flight-testing simulation or emitter and target simulations require long, unique, non-repetitive waveforms. Most arbitrary waveform generators do not have adequate memory to play back these long time records. With this tool, long signal scenarios emulating the actual environment of the receiver can be used to

develop and verify your design – eliminating much of the need for expensive field testing or custom simulator development.

Use this software with the PSG to play back large I/Q waveform data files created from your simulations or captured off the air. These large files can be played back directly from your PC's hard drive or from the Baseband Studio PCI card's 512 MSa RAM through the PSG vector in real time. Alternatively, it may be used with just the digital signal interface module to function as a standalone digital stimulus or waveform capture system. During the capture operation, the captured waveform can be saved to your PC's hard drive, or analyzed with Agilent's 89600 series vector signal analysis software.

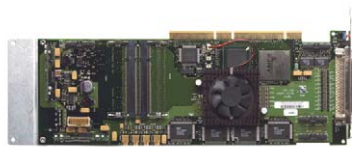

Baseband Studio PCI card

The N5101A Baseband

Studio PCI card is the hardware engine for the N5110B Baseband Studio for waveform capture and playback. A PC equipped with the PCI card is required for this application to function. The PCI card employs an advanced Xilinx field programmable gate array (FPGA), which enables

it to become a high-performance baseband processor that is instantly reconfigurable to accommodate the many signal formats that are processed by the Baseband Studio software applications. This architecture provides the flexibility to enable future applications.

- Up to 512 MSa waveform memory
- 16 bits of vertical resolution
- Dual channel operation
- Flexible digital bus

E8267D PSG Vector Signal Generator

Wideband vector modulation

VECTOR
VECTOR
VECTOR
VECTOR
VECTOR
VECTOR
VECTOR

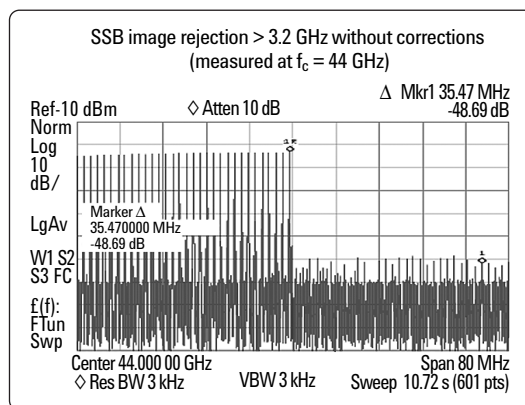
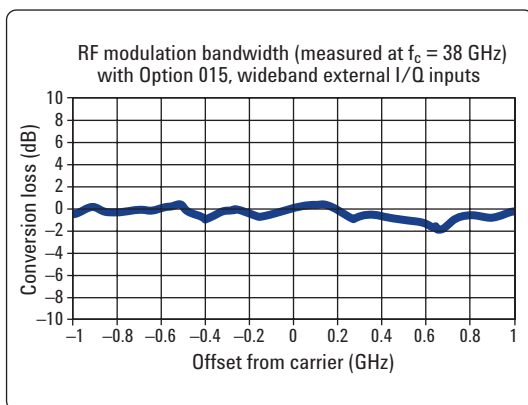

Specification summary¹

Low phase noise (Option UNX)

$f_c = 10$ GHz	
(100 Hz offset)	-92 dBc/Hz
(1 kHz offset)	-109 dBc/Hz
(10 kHz offset)	-114 dBc/Hz
(100 kHz offset)	-115 dBc/Hz

High output power

at $f_c = 20$ GHz	+ 22 dBm
at $f_c = 40$ GHz	+ 18 dBm

CW Level Accuracy

(level = -10 to +10 dBm)

$f_c > 2$ to 20 GHz	± .8 dB
$f_c > 20$ to 32 GHz	± .9 dB
$f_c > 32$ to 40 GHz	± .9 dB

Switching speed (list mode) < 5_{ms} (meas)

Analog modulation (Option UNT)

AM

Bandwidth	100 kHz
Modes	Linear > 95%
	Exponential > 40 dB

FM

Bandwidth	dc to 10 MHz
Maximum deviation	
10 GHz < f_c ≤ 20 GHz	32 MHz
20 GHz < f_c ≤ 28.5 GHz	48 MHz
28.5 GHz < f_c ≤ 44 GHz	80 MHz

ΦM

Bandwidth	dc to 1 MHz
Maximum deviation	
10 GHz < f_c ≤ 20 GHz	320 radians
20 GHz < f_c ≤ 28.5 GHz	480 radians
28.5 GHz < f_c ≤ 44 GHz	800 radians

Pulse modulation (Option UNW)

Rise/fall time	8 ns
Minimum pulse width	20 ns
On/off ratio	80 dB

RF modulation bandwidth

External I/Q inputs	Up to 160 MHz
Wideband external I/Q inputs	Up to 2 GHz ($f_c > 3.2$ GHz)

Internal baseband generator

RF modulation bandwidth	Up to 80 MHz
Waveform playback memory	8 MSa (40 MB) or 64 MSa (320 MB)
Waveform storage memory	1 MSa (5 MB) or 1.2 GSa (6 GB)
Sample rate	Up to 100 MSa/s
Symbol rate	Up to 50 Msym/s
DAC resolution	16-bit

Modulation formats

PSK:	BPSK, QPSK, OQPSK, π /4DQPSK, 8PSK, D8PSK, 16PSK
MSK:	User-defined phase offset from 0 to 100 °
QAM:	4, 16, 32, 64, 128, 256
FSK:	2, 4, 8, 16 level
Custom I/Q:	Custom map of 256 unique I/Q symbols

Multicarrier

Number of carriers	Up to 100
Frequency offset	-40 MHz to +40 MHz
Power offset	0 to -40 dB

Multitone

Number of tones	2 to 64 tones
Phase (per tone)	fixed or random
Power offset (per tone)	0 to -40 dB

1. Numbers in italics indicate typical performance. Specifications are subject to change without notice.

Taking a Closer Look at the PSG

1. I and Q inputs
2. DATA input
3. DATA CLOCK input
4. SYMBOL SYNC input
5. TRIGGER key
6. EXT 1 INPUT for AM, FM, and Φ M
7. EXT 2 INPUT for AM, FM, and Φ M

8. LF OUTPUT for the low-frequency source function generator
9. ALC INPUT for external detector leveling
10. INTERNAL PULSE GENERATOR:
 - GATE/PULSE TRIGGER INPUT
 - VIDEO OUT
 - SYNC OUT

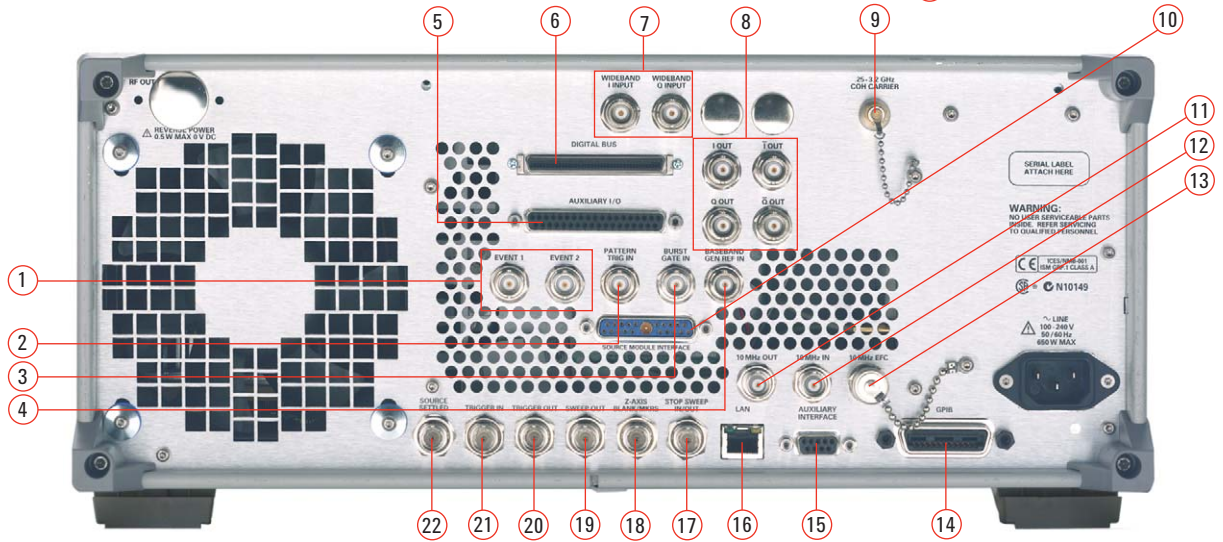

1. EVENT 1 and EVENT 2 outputs marker signals from the baseband generator
2. PATTERN TRIG IN triggers an internal pattern or frame to initiate an output
3. BURST GATE IN for gating bursted power
4. BASEBAND GEN CLK IN
5. AUXILIARY I/O provides access to various inputs and outputs
6. DIGITAL BUS used with Agilent Baseband Studio products
7. WIDEBAND I and Q inputs drive the PSG's wideband (2 GHz) I/Q modulator for custom vector modulation
8. Single-ended and differential I/Q outputs
9. COH (COHERENT CARRIER OUTPUT)
10. SMI (SOURCE MODULE INTERFACE) enables frequency generation up to 110 GHz with Agilent mm-wave source modules

11. 10 MHz Reference OUT
12. 10 MHz Reference IN
13. 10 MHz EFC INPUT
14. GPIB
15. AUXILIARY INTERFACE RS-232 port
16. LAN
17. STOP SWEEP IN/OUT
18. Z-AXIS BLANK/MKRS
19. SWEEP OUT
20. TRIGGER OUT
21. TRIGGER IN
22. SOURCE SETTLED output

Note: available connectors vary depending on the PSG model and option structure configuration

Special Options Available to Meet Your Customized Test Needs

Agilent offers a variety of special options to meet your customized test needs. If you require custom capability or performance, please contact your sales representative to determine if a special option is available or if one can be created to meet your special needs.

Generate up to eight phase-coherent signals

Testing multireceiver systems used in phased-array radar, communications networks, and synthetic aperture radar has traditionally been difficult and expensive. Field-testing, while perhaps necessary for final system verification, is an expensive method for the design phase. The phase-coherent simulation system, which consists of up to eight E8267D PSGs and some special options, provides a more repeatable, configurable alternative for the laboratory or the flight line. As shown, one PSG is the master, which delivers the fundamental LO signal to the lock box. The lock box distributes this signal back to the master and all the slaves as a common reference. The E4438C ESG vector signal generator is used as the source to drive the external clock inputs of each PSG's internal baseband generator. The system provides the full-phase coherency that is mandatory for testing multi-receiver systems, as well as full control over time, phase, amplitude and frequency.

Lock up to eight PSG vector signal generators to achieve phase coherency with special Option HCC

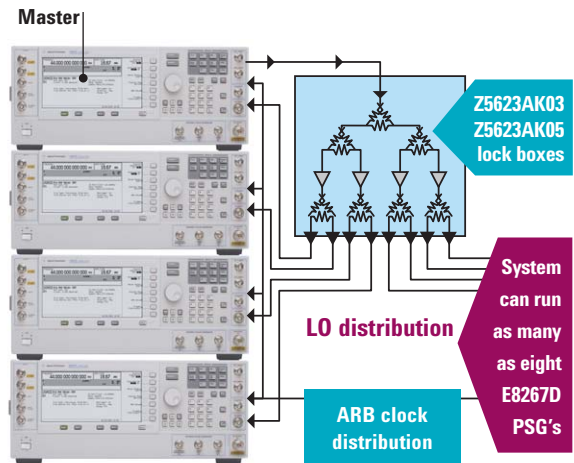

Change the waveform sequence dynamically during playback

In a system level test environment, having the ability to dynamically change the stimulus waveform without discontinuity is a distinct advantage in evaluating system performance. The E8267D dynamic sequencing special Option SP2 enhances the "segment advance" capability of the Option 601 or 602 arbitrary waveform generator to allow jumping to any of 256 different waveform segments in the playback memory. The sequencing enhancement allows determination of the next segment to be made dynamically via an 8-bit value strobe into the rear panel auxiliary I/O D-type connector.

Jump to different waveform segments seamlessly with special Option SP2

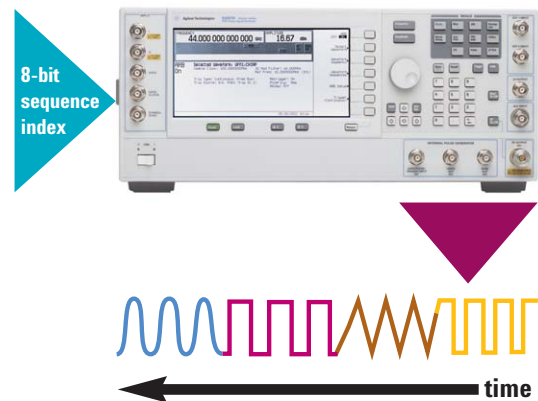

Special Options Available to Meet Your Customized Test Needs

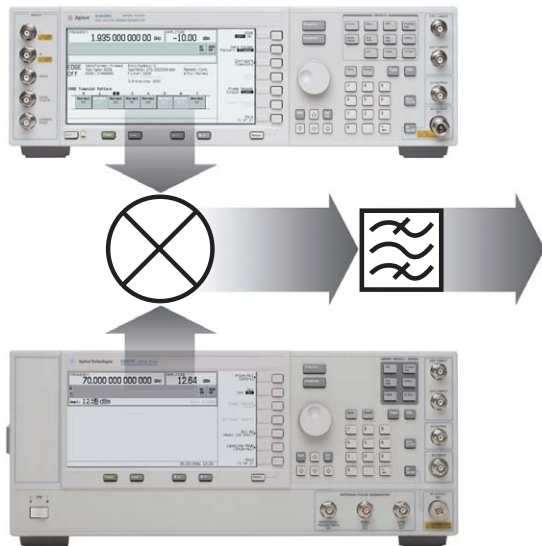

Add an internal mixer to the E8257D

For engineers working in the C, X, Ku, K and Ka bands special option H30 adds an internal mixer to the E8257D (with option 520, 532, or 540) to enable it to upconvert modulated RF signals to frequencies up to 44 GHz.

**Vector modulated signals
at frequencies up to 70 GHz**

For even higher frequencies, special options H60 or H65 can be added to the E8257D (with Option 550 or 565) to achieve vector modulated signals at frequencies up to 70 GHz. An external filter would be needed to eliminate any unwanted mixing products for these special options. For an integrated, higher performance solution to microwave frequency vector signal generator, see the discussion of the E8267D vector model in this brochure (page 7).

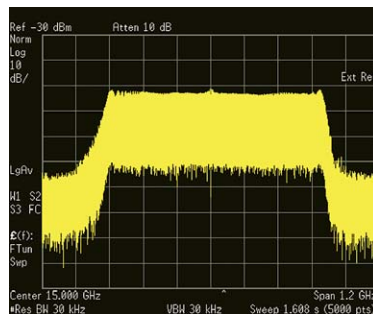

Realize up to 2 GHz modulation bandwidth with external inputs option H16

Wideband external inputs on the E8267D

The E8267D equipped with special option H16 enables external differential I/Q inputs to directly drive the PSG's leading-edge internal I/Q modulator with an external arbitrary waveform generator. For satellite and broadband communications applications, easily achieve up to 2 GHz RF modulation bandwidth using wideband external analog I/Q inputs. Special option H16 provides the bandwidth needed for high symbol rate custom modulation and frequency hopping within the modulation bandwidth.

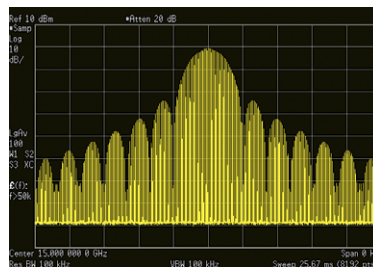

Add deep AM to the PSG for radar antenna test with scan modulation option HSM

Scan modulation

Special option HSM adds scan modulation capability to the E8257D (option 520) for simulating a moving radar antenna beam. Realize up to 60 dB of modulation depth and more dynamic range for power sweep applications.

PSG Signal Generators – A Modular Platform for Current and Future Test Needs

E8257D PSG analog signal generator

Frequency options

520	250 kHz to 20 GHz
532	250 kHz to 31.8 GHz
540	250 kHz to 40 GHz
550	250 kHz to 50 GHz
567	250 kHz to 67 GHz

Hardware options

007	Analog ramp sweep
UNX	Enhanced phase noise performance
UNT	AM, FM, phase modulation, and LF output
UNU	Pulse modulation
UNW	Narrow pulse modulation
1EA	High output power
1E1	Step attenuator
1EH	Improved harmonics below 2 GHz
1EZ	Extended support life

Special options

HSM	Scan modulation (20 GHz model only)
H1S	1 GHz external frequency reference input and output
HCC	Input and output of phase reference LO
H1G	Add 1 GHz external phase reference for frequencies 100 kHz to 250 MHz
H30	Internal mixer for up conversion up to 46 GHz in the 20, 31.8, and 40 GHz models
H60/H65	Internal mixer for up/down conversion up to 65 GHz in the 50 and 67 GHz models

OML Inc. Millimeter source module options

E8257DS15	50 to 75 GHz at +8 dBm
E8257DS12	60 to 90 GHz at +6 dBm
E8257DS10	75 to 110 GHz at +5 dBm
E8257DS08	90 to 140 GHz at -2 dBm
E8257DS06	110 to 170 GHz at -6 dBm
E8257DS05	140 to 220 GHz at -12 dBm
E8257DS03	220 to 325 GHz at -25 dBm

E8267D PSG vector signal generator

Frequency options

520	250 kHz to 20 GHz
532	250 kHz to 31.8 GHz
544	250 kHz to 44 GHz

Hardware options

601	Internal baseband generator, 8 MSA memory
602	Internal baseband generator, 64 MSA memory
003	PSG digital output connectivity with N5102A
004	PSG digital input connectivity with N5102A
005	6 GB internal hard drive
007	Analog ramp sweep
015	Wideband external I/Q inputs
UNX	Ultra low phase noise
UNT	AM, FM, phase modulation, and LF output
UNU	Pulse modulation
UNW	Narrow pulse modulation
1EH	Improved harmonics below 2 GHz
1EZ	Extended support life

Signal Creation software

E8267D-403	Calibrated noise software
E8267D-408	Signal Studio for enhanced multitone
E8267D-420	Signal Studio for pulse building
E8267D-421	Signal Studio for noise power ratio
N7622A	Signal Studio toolkit
N7613A	Signal Studio for 802.16-2004 (WiMAX)
N7619A	Signal Studio for multiband OFDM UWB
N7623A	Signal Studio for DVB

Special options

H00	W-CDMA FDD Personality
H01	cdma200 and IS-95-A Personality
H16	Differential wideband external I/Q inputs
H17	Signal Studio for 802.11 WLAN
H1G	1 GHz reference input and output
HSQ	additional rear panel I/Q inputs
H1S	1 GHz external reference input
HCC	Local oscillator access
SP1	Signal Studio for jitter injection
SP2	Dynamic sequencing capability

Baseband Studio solutions

N5102A	Baseband Studio digital signal interface module
N5101A	Baseband Studio PCI card
N5110B	Baseband Studio for waveform capture and playback

PSG Signal Generators – A Whole Product Solution

Agilent strives to provide complete solutions that go beyond your expectations. In addition to the PSG's high performance, Agilent offers an extensive range of enhancements, software,

services, connectivity, accessibility and support to help you reach your signal stimulus objectives. The PSG is manufactured in an ISO 9001 registered facility to Agilent's exacting standards.

Accessories

- Rack mount kits
- Transit cases
- RF/MW limiters, adapters & cables

Open connectivity for easy system integration

- LAN, GPIB or RS-232 interfaces
- IVI-COM driver
- IntuiLink software for screen captures
- EEsof Advanced Design System driver (instrument link)
- SCPI (Standard Commands for Programmable Instruments)
- 8757D scalar network analyzer compatibility
- Backwards code compatible with legacy instruments

Pre-sales services

- Rentals, leasing, and financing
- Application engineering and consulting services
- Application notes
- Custom product modifications
- Product literature available from Agilent's Web site
- Demonstration units available for evaluation
- Trade-up programs
- Support at least 5 years, optionally 10 years, beyond production life of product

Post-sales support

- Standard warranty
- Worldwide call center and calibration service center support network
- 2-year calibration intervals
- Free firmware upgrades and service notes available from Agilent's Web site
- PC-based calibration software
- Flexible support options to meet your needs

Training and access to information

- Factory service training
- Web-based support of frequently asked questions
- Operation, programming and calibration manuals on CD-ROM and on Agilent's Web site
- User and applications training
- Technical seminars
- Calibration certificate standard

Additional Resources

Product literature

Agilent E8257D PSG Analog Signal Generator,
Data Sheet, Literature number 5989-0698EN

Agilent E8257D PSG Analog Signal Generator,
Configuration Guide,
Literature number 5989-1325EN

Agilent E8267D PSG Vector Signal Generator,
Data Sheet, Literature number 5989-0697EN

Agilent E8267D PSG Vector Signal Generator,
Configuration Guide,
Literature number 5989-1326EN

Agilent PSG Two-tone and Multitone,
Application Note 1410
Literature number 5988-7689EN

Agilent Radar Emitter Simulation,
Application Note, Literature number 5988-9212EN

Web

For more information or to view product literature on-line, please visit:

www.agilent.com/find/psg

www.agilent.com/find/signalstudio

www.agilent.com/find/basebandstudio

Learn more about microwave accessories, visit:
www.agilent.com/find/accessories



Agilent Email Updates

www.agilent.com/find/emailupdates

Get the latest information on the products and applications you select.

MATLAB is a U.S. registered trademark of The Math Works, Inc.

www.agilent.com

Agilent Technologies' Test and Measurement Support, Services, and Assistance

Agilent Technologies aims to maximize the value you receive, while minimizing your risk and problems. We strive to ensure that you get the test and measurement capabilities you paid for and obtain the support you need. Our extensive support resources and services can help you choose the right Agilent products for your applications and apply them successfully. Every instrument and system we sell has a global warranty. Two concepts underlie Agilent's overall support policy: "Our Promise" and "Your Advantage."

Our Promise

Our Promise means your Agilent test and measurement equipment will meet its advertised performance and functionality. When you are choosing new equipment, we will help you with product information, including realistic performance specifications and practical recommendations from experienced test engineers. When you receive your new Agilent equipment, we can help verify that it works properly and help with initial product operation.

Your Advantage

Your Advantage means that Agilent offers a wide range of additional expert test and measurement services, which you can purchase according to your unique technical and business needs. Solve problems efficiently and gain a competitive edge by contracting with us for calibration, extra-cost upgrades, out-of-warranty repairs, and onsite education and training, as well as design, system integration, project management, and other professional engineering services. Experienced Agilent engineers and technicians worldwide can help you maximize your productivity, optimize the return on investment of your Agilent instruments and systems, and obtain dependable measurement accuracy for the life of those products.



Agilent Open

www.agilent.com/find/open

Agilent Open simplifies the process of connecting and programming test systems to help engineers design, validate and manufacture electronic products. Agilent offers open connectivity for a broad range of system-ready instruments, open industry software, PC-standard I/O and global support, which are combined to more easily integrate test system development.

United States:

(tel) 800 829 4444

(fax) 800 829 4433

Canada:

(tel) 877 894 4414

(fax) 800 746 4866

China:

(tel) 800 810 0189

(fax) 800 820 2816

Europe:

(tel) 31 20 547 2111

Japan:

(tel) (81) 426 56 7832

(fax) (81) 426 56 7840

Korea:

(tel) (080) 769 0800

(fax) (080)769 0900

Latin America:

(tel) (305) 269 7500

Taiwan:

(tel) 0800 047 866

(fax) 0800 286 331

Other Asia Pacific Countries:

(tel) (65) 6375 8100

(fax) (65) 6755 0042

Email: tm_ap@agilent.com

Contacts revised: 05/27/05

For more information on Agilent Technologies' products, applications or services, please contact your local Agilent office. The complete list is available at:

www.agilent.com/find/contactus

Product specifications and descriptions in this document subject to change without notice.

© Agilent Technologies, Inc. 2005, 2006

Printed in USA, March 9, 2006

5989-1324EN



Agilent Technologies